

DATA SHEET

OLI100: Miniature Phototransistor Optocoupler for Hybrid Assembly

Features

- Current transfer ratio guaranteed over -55 °C to +125 °C ambient temperature range
- Electrical isolation: 1500 VDC
- High current transfer ratio: 100% minimum over temperature
- High current transfer ratio at low input current: 100% at $I_F = 1 \text{ mA}$ over temperature
- High reliability and rugged construction
- CTR-comparable to Darlington output but with low saturation $V_{CE} = 0.15 \text{ V}$ typical
- Similar to 4N2X, 4N3X type optocouplers
- Custom package available

Description

The OLI100 is designed especially for hybrid applications that require optical isolation with a high current transfer ratio and low saturation V_{CE} . The device consists of a light emitting diode, and an N-P-N silicon phototransistor mounted and coupled in a miniature custom ceramic package.

The very low input current makes the OLI100 well suited for direct CMOS to Low Power Schottky Transistor to Transistor Logic (LSTTL/TTL) interfaces.

The OLI100 is mounted by standard hybrid assembly with non-conductive epoxies. Gold or aluminum wire bonding can be used to make electrical connections for maximum placement flexibility.

NOTE: Certain cleaning processes may be harmful to this device. Please consult Isolink for details.

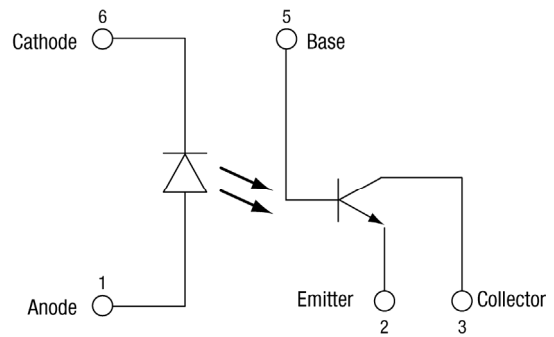

S2787

Figure 1. OLI100 Block Diagram

A functional block diagram of the OLI100 is shown in Figure 1. The absolute maximum ratings of the OLI100 are provided in Table 1. Electrical specifications are provided in Table 2.

Typical performance characteristics of the OLI100 are illustrated in Figures 2 through 5. A typical switching test circuit is shown in Figure 6 and package dimensions for the OLI100 are provided in Figure 7.

Table 1. OLI100 Absolute Maximum Ratings¹

Parameter	Symbol	Minimum	Maximum	Units
<i>Coupled</i>				
Input to output isolation voltage ²	V _{DC}		±1500	V
Storage temperature	T _{STG}	-65	+150	°C
Operating temperature	T _A	-55	+125	°C
Mounting temperature (3 minutes maximum)	T _{MTG}		+240	°C
<i>Input Diode</i>				
Average input current	I _{DD}		40	mA
Peak forward current (≤ 1 ms duration)	I _F		60	mA
Reverse voltage	V _R		3	V
Power dissipation	P _D		70	mW
<i>Output Detector</i>				
Collector to emitter voltage	V _{CE}		35	V
Emitter to collector voltage	V _{EC}		7	V
Collector to base voltage	V _{CB}		70	V
Power dissipation ³	P _D		300	mW

¹ Exposure to maximum rating conditions for extended periods may reduce device reliability. There is no damage to device with only one parameter set at the limit and all other parameters set at or below their nominal value. Exceeding any of the limits listed here may result in permanent damage to the device.

² Measured between pins 1 and 6 shorted together and pins 2, 3, 4, and 5 shorted together. T_A = 25 °C and duration = 1 second.

³ Derate linearly at 3.0 mW/°C above 25 °C.

ESD HANDLING: *Although this device is designed to be as robust as possible, electrostatic discharge (ESD) can damage this device. This device must be protected at all times from ESD when handling or transporting. Static charges may easily produce potentials of several kilovolts on the human body or equipment, which can discharge without detection. Industry-standard ESD handling precautions should be used at all times.*

Table 2. OLI100 Electrical Specifications¹
(T_A = -55 °C to +125 °C, Unless Otherwise Noted)

Parameter	Symbol	Test Condition	Min	Typ	Max	Units
Current transfer ratio ²	CTR	I _F = 10 mA, V _{CE} = 5 V	100	200		%
		I _F = 1 mA, V _{CE} = 5 V	100	200		%
Saturation voltage	V _{CE_SAT}	I _F = 10 mA, I _C = 2 mA		0.15	0.30	V
Breakdown voltage: Collector to emitter Collector to base Emitter to collector	BV _{CEO}	I _{CE} = 100 μA, T _A = 25 °C	30			V
	BV _{CBO}	I _{CB} = 10 μA, T _A = 25 °C	70			V
	BV _{ECO}	I _{EC} = 100 μA, T _A = 25 °C	5			V
Leakage current (collector to emitter)	I _{CEO}	V _{CE} = 20 V, T _A = 25 °C			100	nA
		V _{CE} = 20 V, T _A = 100 °C			100	μA
Input forward voltage	V _F	I _F = 10 mA	0.9	1.3	1.7	V
Input reverse current	I _R	V _R = 3 V			100	μA
Input to output leakage current ³	I _{I_O}	Relative humidity ≤50%, T _A = 25 °C, V _{I_O} = 1500 V _{DC}			1	μA
Turn-on time	t _{ON}	V _{CC} = 10 V, R _L = 100 Ω, I _C = 2 mA, T _A = 25 °C		5	15	μs
Turn-off time	t _{OFF}	V _{CC} = 10 V, R _L = 100 Ω, I _C = 2 mA, T _A = 25 °C		5	15	μs

¹ Performance is guaranteed only under the conditions listed in this table.
² CTR is defined as the ratio of output collector current (I_C) to the forward LED current (I_F) multiplied by 100%.
³ Measured between pins 1 and 6 shorted together and pins 2, 3, 4, and 5 shorted together. T_A = 25 °C and duration = 1 second.

Typical Performance Characteristics
 (T_{OP} = -55 °C to +125 °C, Unless Otherwise Noted)

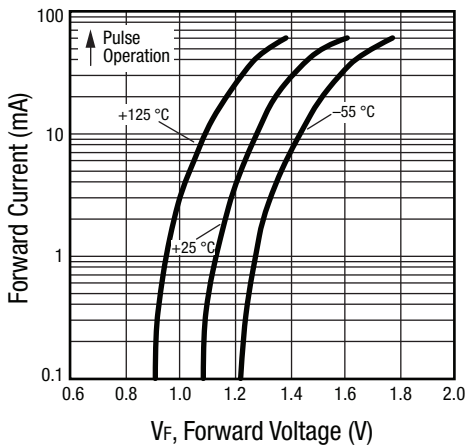

Figure 2. Diode Forward Characteristics

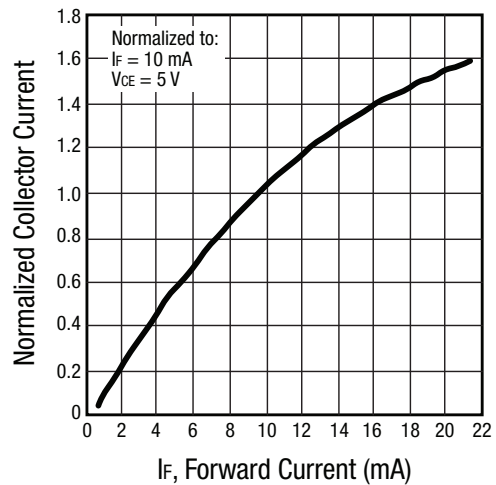

Figure 3. Normalized Collector Current vs. Forward Current

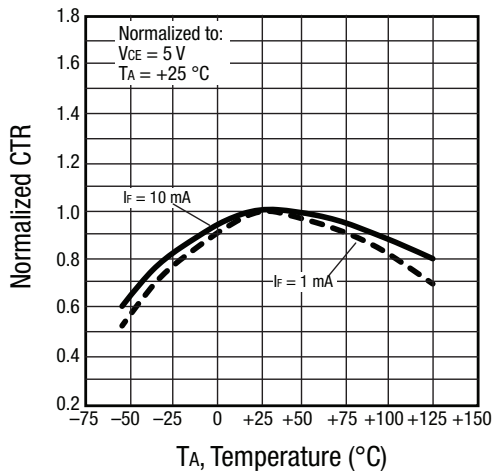

Figure 4. Normalized CTR vs Temperature

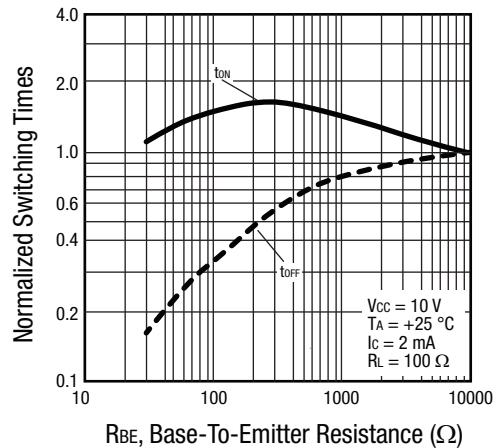

Figure 5. Switching Speed vs Base-to-Emitter Resistance

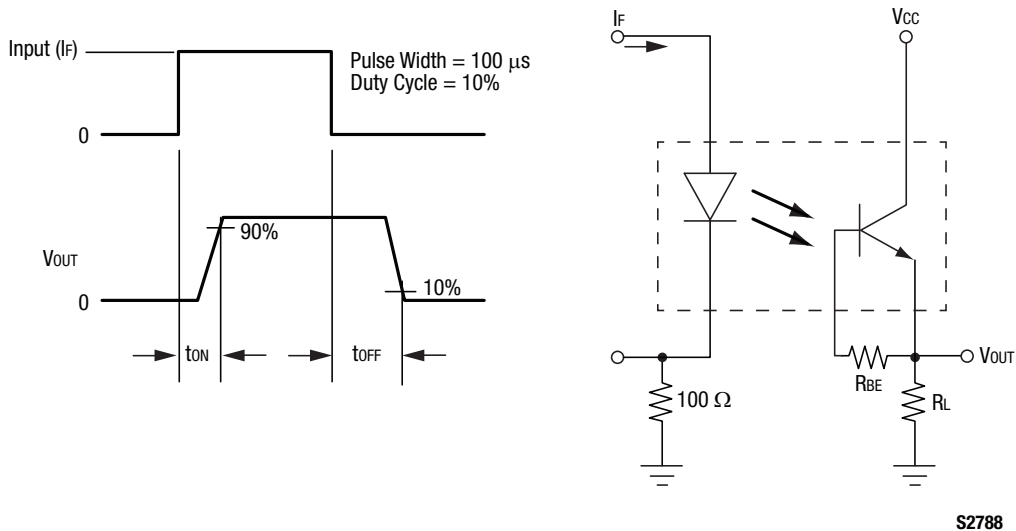

Figure 6. OLI100 Switching Test Circuit

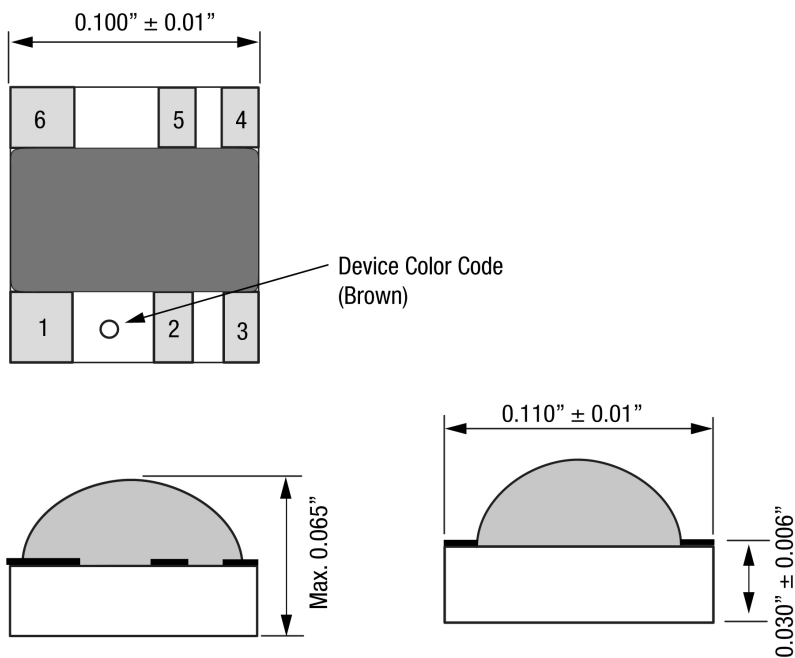

Figure 7. OLI100 Package Dimensions

Ordering Information

Part Number	Product Description
OLI100	Miniature Phototransistor Optocoupler for Hybrid Assembly

Copyright © 2012-2015, 2017-2018, 2020 Isolink, Inc. All Rights Reserved.

Information in this document is provided in connection with Isolink, Inc. ("Isolink"), a wholly-owned subsidiary of Skyworks Solutions, Inc. These materials, including the information contained herein, are provided by Isolink as a service to its customers and may be used for informational purposes only by the customer. Isolink assumes no responsibility for errors or omissions in these materials or the information contained herein. Isolink may change its documentation, products, services, specifications or product descriptions at any time, without notice. Isolink makes no commitment to update the materials or information and shall have no responsibility whatsoever for conflicts, incompatibilities, or other difficulties arising from any future changes.

No license, whether express, implied, by estoppel or otherwise, is granted to any intellectual property rights by this document. Isolink assumes no liability for any materials, products or information provided hereunder, including the sale, distribution, reproduction or use of Isolink products, information or materials, except as may be provided in Skyworks Terms and Conditions of Sale.

THE MATERIALS, PRODUCTS AND INFORMATION ARE PROVIDED "AS IS" WITHOUT WARRANTY OF ANY KIND, WHETHER EXPRESS, IMPLIED, STATUTORY, OR OTHERWISE, INCLUDING FITNESS FOR A PARTICULAR PURPOSE OR USE, MERCHANTABILITY, PERFORMANCE, QUALITY OR NON-INFRINGEMENT OF ANY INTELLECTUAL PROPERTY RIGHT; ALL SUCH WARRANTIES ARE HEREBY EXPRESSLY DISCLAIMED. ISOLINK DOES NOT WARRANT THE ACCURACY OR COMPLETENESS OF THE INFORMATION, TEXT, GRAPHICS OR OTHER ITEMS CONTAINED WITHIN THESE MATERIALS. ISOLINK SHALL NOT BE LIABLE FOR ANY DAMAGES, INCLUDING BUT NOT LIMITED TO ANY SPECIAL, INDIRECT, INCIDENTAL, STATUTORY, OR CONSEQUENTIAL DAMAGES, INCLUDING WITHOUT LIMITATION, LOST REVENUES OR LOST PROFITS THAT MAY RESULT FROM THE USE OF THE MATERIALS OR INFORMATION, WHETHER OR NOT THE RECIPIENT OF MATERIALS HAS BEEN ADVISED OF THE POSSIBILITY OF SUCH DAMAGE.

Isolink products are not intended for use in medical, lifesaving or life-sustaining applications, or other equipment in which the failure of the Isolink products could lead to personal injury, death, physical or environmental damage. Isolink customers using or selling Isolink products for use in such applications do so at their own risk and agree to fully indemnify Isolink for any damages resulting from such improper use or sale.

Customers are responsible for their products and applications using Isolink products, which may deviate from published specifications as a result of design defects, errors, or operation of products outside of published parameters or design specifications. Customers should include design and operating safeguards to minimize these and other risks. Isolink assumes no liability for applications assistance, customer product design, or damage to any equipment resulting from the use of Isolink products outside of stated published specifications or parameters.

Isolink is a trademark of Isolink, Inc. in the United States and other countries. Skyworks and the Skyworks symbol are trademarks or registered trademarks of Skyworks Solutions, Inc. or its subsidiaries in the United States and other countries. Third-party brands and names are for identification purposes only, and are the property of their respective owners.