

DATA SHEET

SKY66189-11: 1930 to 1995 MHz Linear Power Amplifier

Applications

- 3G/4G LTE Bands 2 and 25 small cell
- Active distributed antenna system
- Cellular repeaters
- Driver amplifier

Features

- High gain: 40 dB (unconditionally stable)
- High linearity: +23 dBm with -50 dBc ACLR @ 85 °C (WCDMA Test Model 1 with 64 DPCH)
- RF input and output internally matched to 50 ohms
- Excellent output return loss: < -20 dB
- Integrated active bias: performance compensated over temp
- PA On/Off function: 3.5 us switching time
- Integrated coupler for output power monitoring
- Single supply voltage: 3.3 V
- Pin-to-pin compatible PA family supporting all 3GPP bands
- Small 5 x 5 mm, 28-pin package (MSL3, 260 °C per JEDEC J-STD-020)



Skyworks Green™ products are compliant with all applicable legislation and are halogen-free. For additional information, refer to *Skyworks Definition of Green™*, document number SQ04-0074.

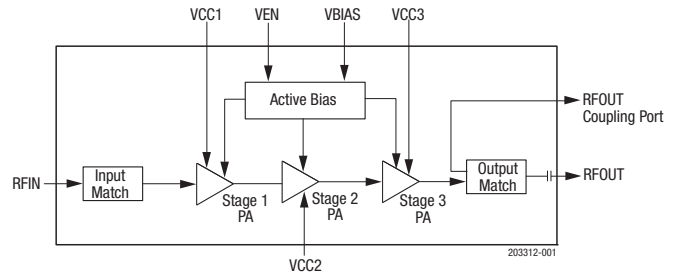

Figure 1. SKY66189-11 Linear PA Block Diagram

Description

The SKY66189-11 is a high-linearity power amplifier (PA) with fully matched input/output and high gain. The compact 5 x 5 mm PA is designed for FDD 3G/4G LTE small cell base stations operating from 1930 to 1995 MHz. The active biasing circuitry is integrated to compensate PA performance over temperature, voltage, and process variation as well as an internal coupler for power monitoring.

The SKY66189-11 requires minimal external components and is part of a high-linearity, pin-to-pin compatible PA family supporting all 3GPP bands.

A block diagram of the SKY66189-11 is shown in Figure 1. The device package and pinout for the 28-pin device are shown in Figure 2. Table 1 lists the pin-to-pin compatible parts in the PA family. Signal pin assignments and functional pin descriptions are described in Table 2.

Table 1. Pin-to-Pin Compatible PA Family

Part Number	Frequency (MHz)	LTE Band
SKY66181-11	1805 to 1880	3
SKY66184-11	2110 to 2170	1, 4, and 10
SKY66185-11	851 to 894	5, 6, 18, 19, 26, and 27
SKY66186-11	728 to 768	12, 13, 14, and 17
SKY66187-11	2620 to 2690	7
SKY66188-11	758 to 803	28
SKY66189-11	1930 to 1995	2 and 25

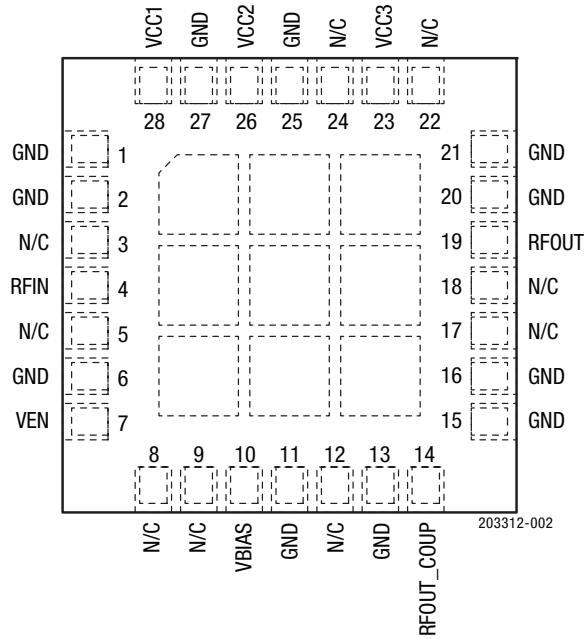

Figure 2. SKY66189-11 Pinout (Top View)

Table 2. SKY66189-11 Signal Descriptions

Pin	Name	Description	Pin	Name	Description
1	GND	Ground	15	GND	Ground
2	GND	Ground	16	GND	Ground
3	N/C	No internal connection	17	N/C	No internal connection
4	RFIN	RF input	18	N/C	No internal connection
5	N/C	No internal connection	19	RFOUT	RF output
6	GND	Ground	20	GND	Ground
7	VEN	Enable (active low)	21	GND	Ground
8	N/C	No internal connection	22	N/C	No internal connection
9	N/C	No internal connection	23	VCC3	Output stage supply voltage
10	VBIAS	Bias voltage	24	N/C	No internal connection
11	GND	Ground	25	GND	Ground
12	N/C	No internal connection	26	VCC2	Stage 2 PA supply voltage
13	GND	Ground	27	GND	Ground
14	RFOUT_COUP	RF output coupling port	28	VCC1	Input stage supply voltage

Technical Description

The SKY66189-11 PA contains all of the needed RF matching and DC biasing circuits. This three-stage device is optimized for high linearity and power efficiency. These features make the device suitable for wideband applications where PA linearity and power consumption are of critical importance (e.g., small cell and infrastructure applications).

The device is designed for standard WCDMA and LTE modulated signals. Under these stringent test conditions, the device exhibits excellent spectral purity and power efficiency.

Electrical and Mechanical Specifications

The absolute maximum ratings of the SKY66189-11 are provided in Table 3. The recommended operating conditions are specified in Table 4, and electrical specifications are provided in Table 5.

Typical performance characteristics are shown in Figures 3 through 14.

Table 3. SKY66189-11 Absolute Maximum Ratings¹

Parameter	Symbol	Minimum	Maximum	Units
Supply voltage (VCC)	VCC	0	+4.0	V
Total supply current	ICC		1800	mA
Logic control input voltage (VEN)	VEN	-0.5	3.6	V
RF input	RFINMAX		+5	dBm
Case operating temperature ²	TC	-40	+98	°C
Storage temperature	TSTG	-55	+150	°C
Junction temperature	TJ		+150	°C
Thermal resistance	θJC		21.7	°C/W
Power dissipation	Pd		1.6	W
Ruggedness @ POUT = +23 dBm (WCDMA TM1 signal, all phases)			10:1 VSWR	
Electrostatic discharge:	ESD			
Charged Device Model (CDM), Class 4			500	V
Human Body Model (HBM), Class 1C			150	V

¹ Exposure to maximum rating conditions for extended periods may reduce device reliability. There is no damage to device with only one parameter set at the limit and all other parameters set at or below their nominal value. Exceeding any of the limits listed here may result in permanent damage to the device.

² Case operating temperature (Tc) refers to the temperature of the bottom ground pad.

ESD HANDLING: *Although this device is designed to be as robust as possible, electrostatic discharge (ESD) can damage this device. This device must be protected at all times from ESD when handling or transporting. Static charges may easily produce potentials of several kilovolts on the human body or equipment, which can discharge without detection. Industry-standard ESD handling precautions should be used at all times.*

Table 4. SKY66189-11 Recommended Operating Conditions

Parameter	Symbol	Min	Typ	Max	Units
Frequency range	f	1930		1995	MHz
Supply voltage (VCC1, VCC2, VCC3) ¹	Vcc	3.0	3.3	3.6	V
PA enable control voltage (active low):					
Disable	VENH	2.5		3.6	V
Enable	VENL	0		0.6	V
PA enable current (@ PAEN = 3.6 V)	IEN			< 1	mA
Case operating temperature	Tc	0	+40	+85	°C

¹ Voltage levels measured at the pads of the package. The Evaluation Board supply voltage levels may be different.

Table 5. SKY66189-11 Electrical Specifications ¹

(Vcc = +3.3 V, Tc = +25 °C, f = 1960 MHz, Characteristic Impedance [Z0] = 50 ohms, VEN = 0 V, Unless Otherwise Noted)

Parameter	Symbol	Test Condition	Min	Typical	Max	Units
Gain	G@23dBm	CW, POUT = +23 dBm	38	40		dB
Input return loss	IS11I	CW, PIN = -30 dBm	8	10		dB
Output return loss:	IS22I	CW, PIN = -30 dBm:				
In-band		In-band frequency: 1930 and 1995 MHz	17	20		dB
Out-of-band		Out-of-band frequency: 1850 and 2070 MHz	12	16		dB
Quiescent current	ICQ	No RF		370	430	mA
Operating current	ICC	CW, POUT = +23 dBm		660	730	mA
Power-down current: ²	IPD	VEN = 2.5 V		0.1	0.5	mA
Harmonics:						
2fo @ +23 dBm	2fo			-50	-42	dBc
3fo @ +23 dBm	3fo			-60	-48	dBc
Adjacent channel leakage ratio	ACLR	5 MHz offset, WCDMA test model 1, with 64 DPCH, 8.5 dB PAR, POUT = +23 dBm		-50	-46.5	dBc
Output 1 dB compression point	OP1dB	CW (Gain compression less than 1dB reference to G@23dBm)	+30	+31		dBm
Power-added efficiency	PAE	CW @ POUT = +23 dBm	8.0	10		%
Output coupling factor	CPLOUT	POUT = +23 dBm, CW	20.5	22.5	24.5	dB

¹ Performance is guaranteed only under the conditions listed in this table.

² Verified by characterization.

Typical Performance Characteristics

(Vcc = +3.3 V, Tc = +25 °C, f = 1960 MHz, Characteristic Impedance [Z0] = 50 ohms, VEN = 0 V, Unless Otherwise Noted)

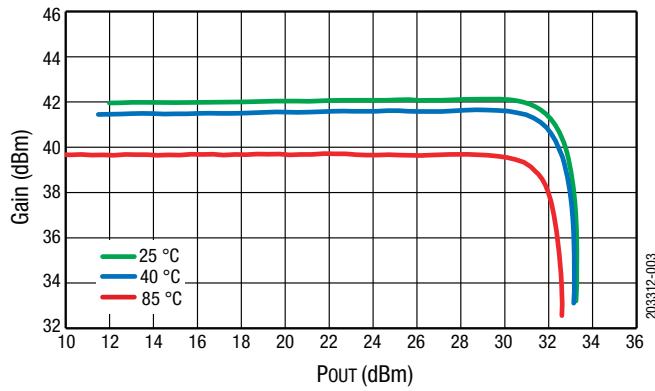

Figure 3. Gain vs Output Power Across Temperature

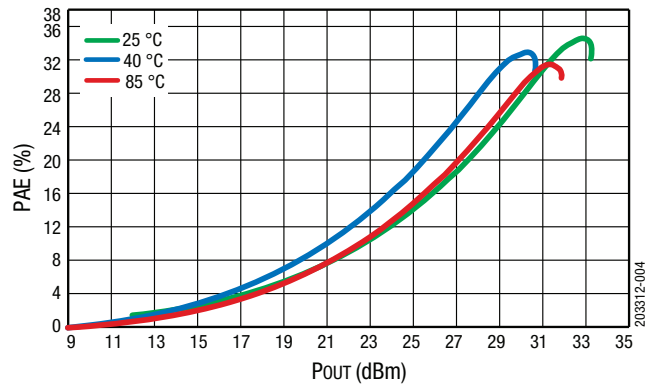

Figure 4. PAE vs POUT Across Temperature

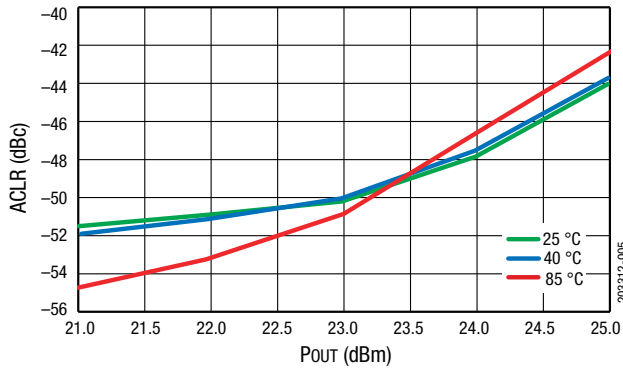

Figure 5. ACLR vs Output Power Across Temperature

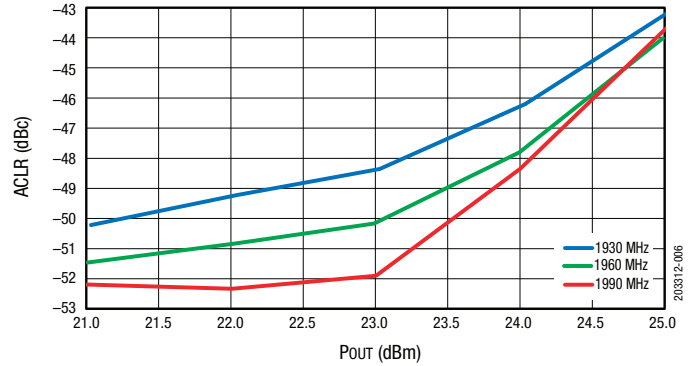

Figure 6. ACLR (5 MHz) vs POUT Across Frequency

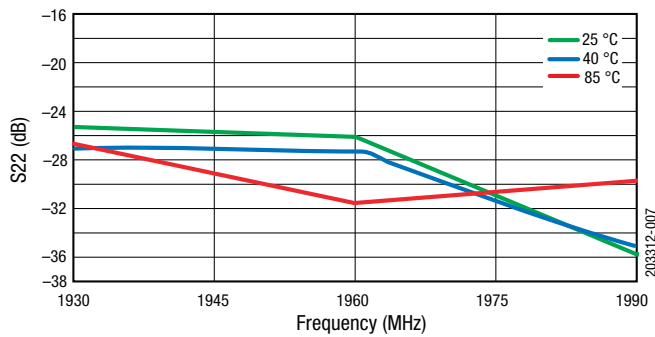

Figure 7. S22 vs Frequency Across Temperature

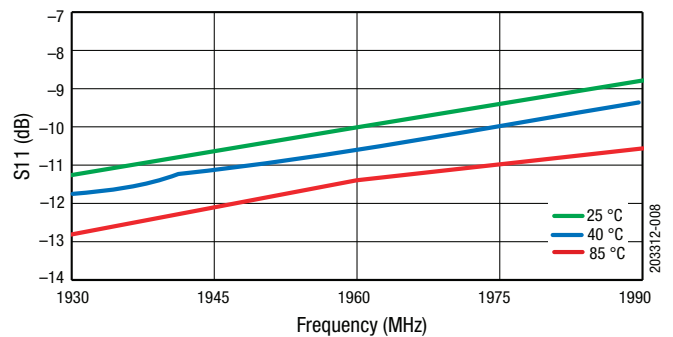

Figure 8. S11 vs Frequency Across Temperature

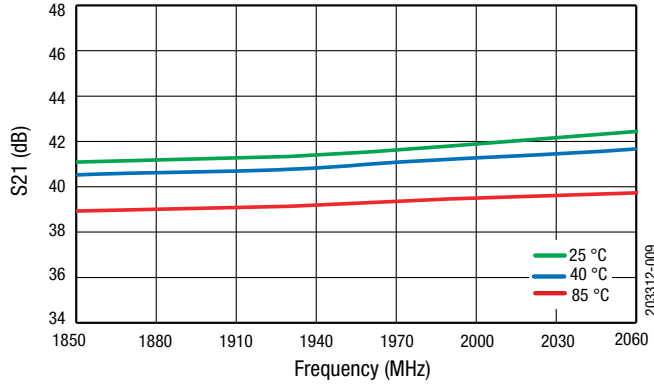

Figure 9. S21 vs Frequency Across Temperature

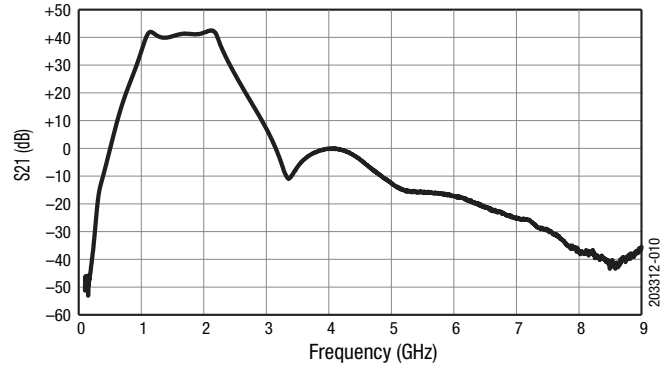

Figure 10. S21 vs Frequency

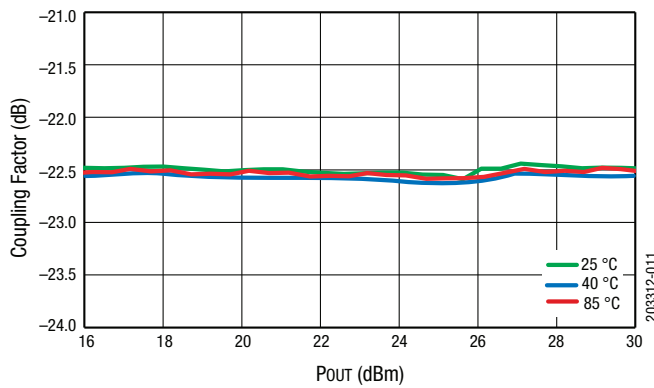

Figure 11. Coupling Factor vs Pout Across Temperature (1960 MHz, 3.3 V)

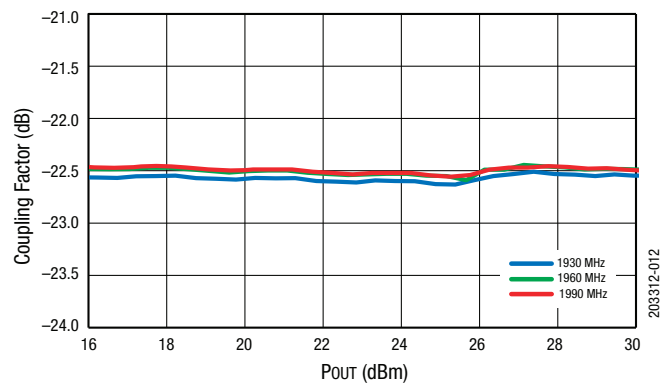

Figure 12. Coupling Factor vs Pout Across Frequency (3.3 V, 25 °C)

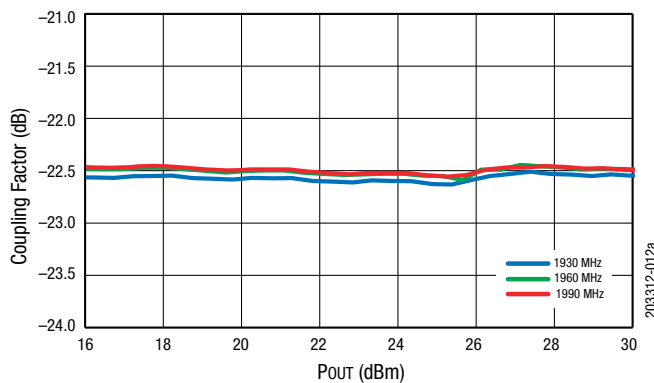

Figure 13. 2nd Harmonic @ +23 dBm vs. Frequency Across Temperature

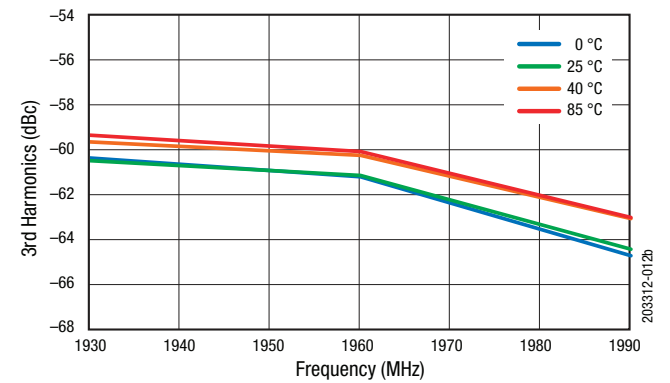

Figure 14. 3rd Harmonic @ +23 dBm vs. Frequency Across Temperature

Evaluation Board Description

The SKY66189-11 Evaluation Board is used to test the performance of the SKY66189-11 PA. A typical application schematic diagram is shown in Figure 15. A Bill of Materials for the SKY66189-11 Evaluation Board is listed in Table 6. An assembly drawing for the Evaluation Board is shown in Figure 16. The board layer detail is shown in Figure 17. The layer detail physical characteristics are shown in Figure 18.

Application Circuit Notes

Center Ground. It is extremely important to sufficiently ground the bottom ground pad of the device for both thermal and stability reasons. Multiple small vias are acceptable and work well under the device if solder migration is an issue.

GND (pins 1, 2, 6, 11, 13, 15, 16, 20, 21, 25, and 27). Attach all ground pins to the RF ground plane with the largest diameter and lowest inductance via that the layout allows. Multiple small vias are acceptable and work well under the device if solder migration is an issue.

VBIAS (pin 10). The bias supply voltage for each stage, nominally set to +3.3 V.

RFOUT (pin 19). Amplifier RF output pin ($Z_0 = 50$ ohms). The module includes an onboard internal DC blocking capacitor. All impedance matching is provided internal to the module.

VCC1, VCC2, and VCC3 (pins 28, 26, and 23, respectively). Supply voltage for each stage collector bias is nominally set to 3.3 V. Bypass and decoupling capacitors C1, C2, C3, C4, C5, and C6 should be placed in the approximate location shown on the evaluation board assembly drawing, although exact placement is not critical.

RFIN (pin 4). Amplifier RF input pin ($Z_0 = 50$ ohms). All impedance matching is provided internal to the module.

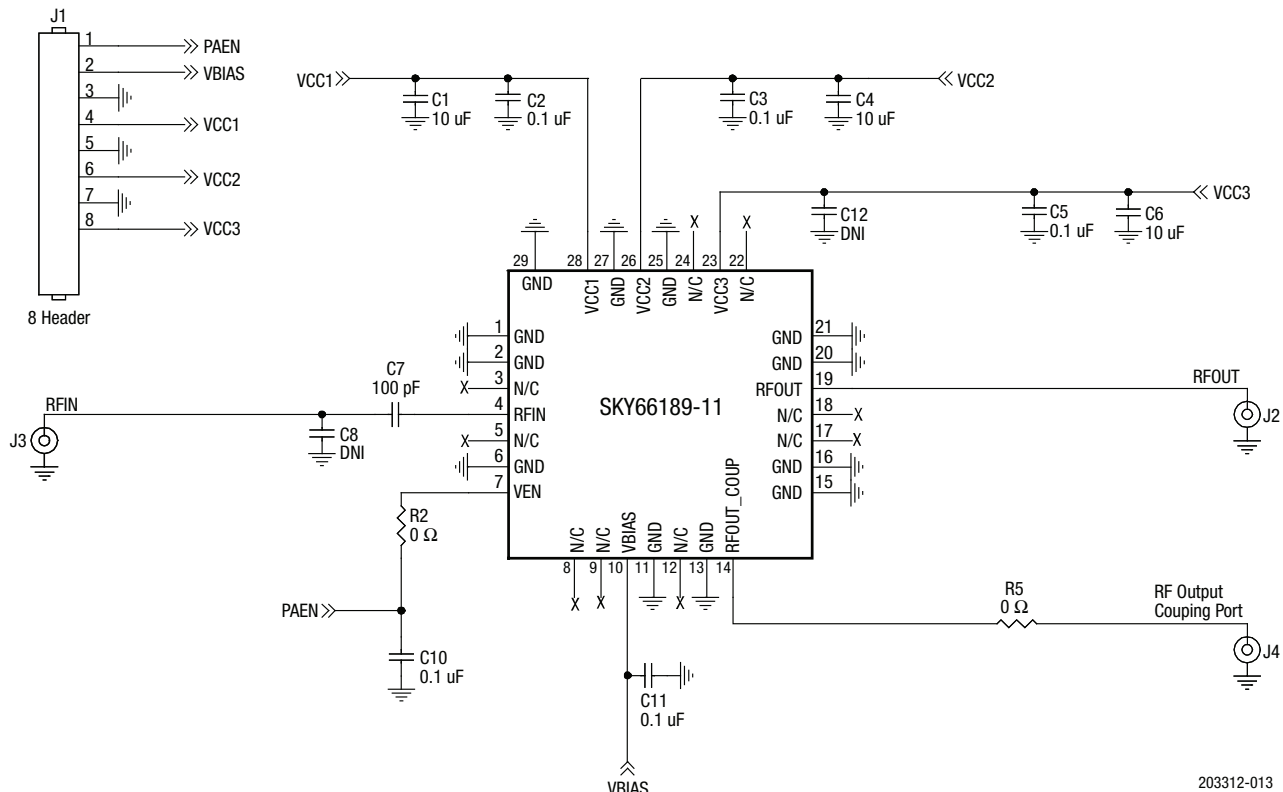
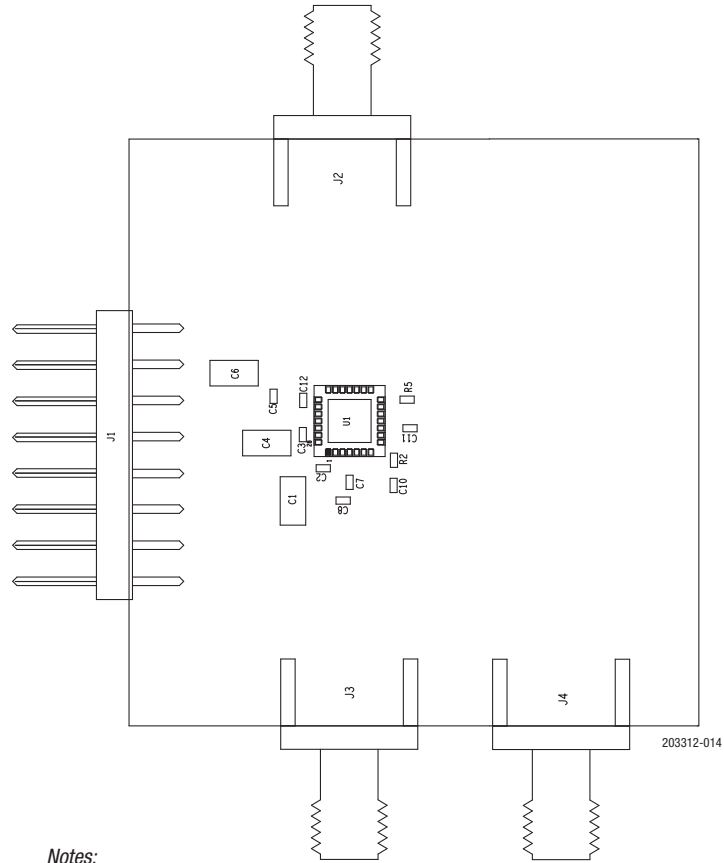

Figure 15. SKY66189-11 Application Schematic

Table 6. SKY66189-11 Evaluation Board Bill of Materials (BoM)

Quantity	Component	Size	Part Number	Description
3	C1, C4, C6	1206	C1206X7R160-106KNE	Capacitor, 10 uF, 16 V, ±10%, X7R
5	C2, C3, C5, C10, C11	0402	GRM155R71C104KA88	Ceramic capacitor, 0.1 uF, 10%, X7R, 16 V
1	C7	0402	GRM1555C1H101JZ01J	Capacitor, 100 pF, 50 V, 5%, COG/NPO
2	C8, C12		DNI	DNI
2	R2, R5	0402	ERJ2GE0R00	Resistor, 0 ohm jumper, 0.063 W
1		PCB	TW22-D115-003	SKY66189



Notes:

*The C3 and C4 components are not required.
Some of the other components shown are optional.*

Figure 16. SKY66189-11 Evaluation Board Assembly Diagram

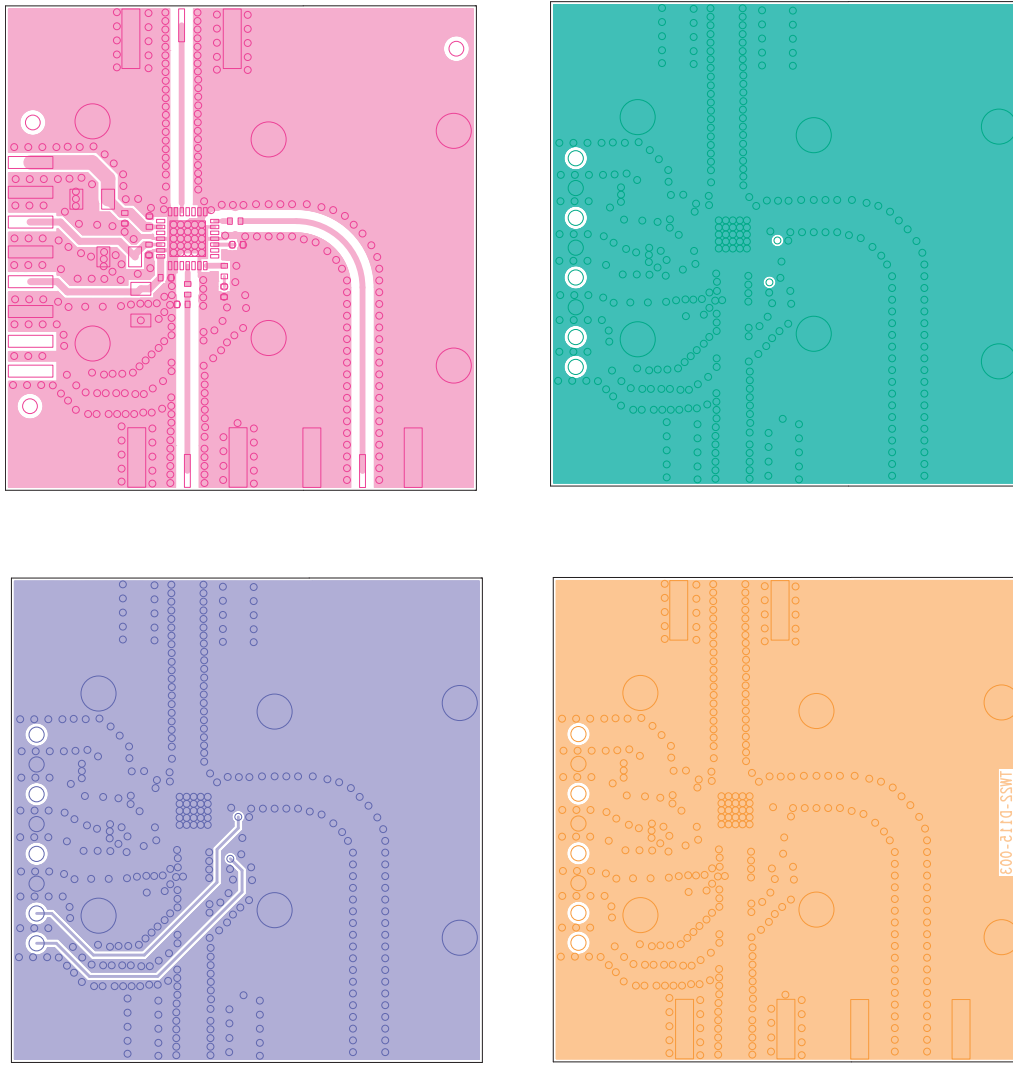

203312-015

Figure 17. SKY66189-11 Board Layer Detail

50 Ω	Cross Section	Name	Thickness (mm)	Material
W = 0.500		TMask	0.010	Solder Resist
		L1	0.035	Cu – 1 oz
		Dielectric	0.250	Rogers 4350B
		L2	0.035	Cu – 1 oz
		Dielectric	0.500	FR4
		L3	0.035	Cu – 1 oz
		Dielectric	0.250	FR4
		L4	0.035	Cu – 1 oz
		BMask	0.010	Solder Resist

203312-013

Figure 18. SKY66189-11 Layer Detail Physical Characteristics

Package Dimensions

The typical part marking is shown in Figure 19. Figure 20 shows the PCB layout footprint. Figure 21 shows the package dimensions, and Figure 22 provides the tape and reel dimensions.

Package and Handling Information

Since the device package is sensitive to moisture absorption, it is baked and vacuum packed before shipping. Instructions on the shipping container label regarding exposure to moisture after the container seal is broken must be followed. Otherwise, problems related to moisture absorption may occur when the part is subjected to high temperature during solder assembly.

The SKY66189-11 is rated to Moisture Sensitivity Level 3 (MSL3) at 260 °C. It can be used for lead or lead-free soldering. For additional information, refer to the Skyworks Application Note, *PCB Design and SMT Assembly/Rework Guidelines for MCM-L Packages*, document number 101752.

Care must be taken when attaching this product, whether it is done manually or in a production solder reflow environment. Production quantities of this product are shipped in a standard tape and reel format.

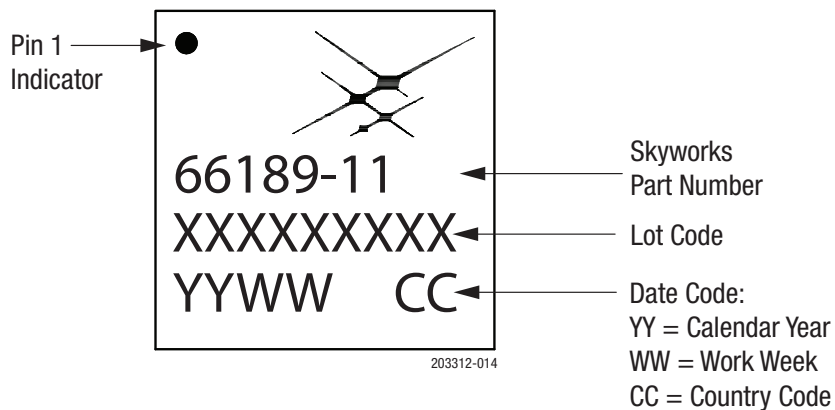
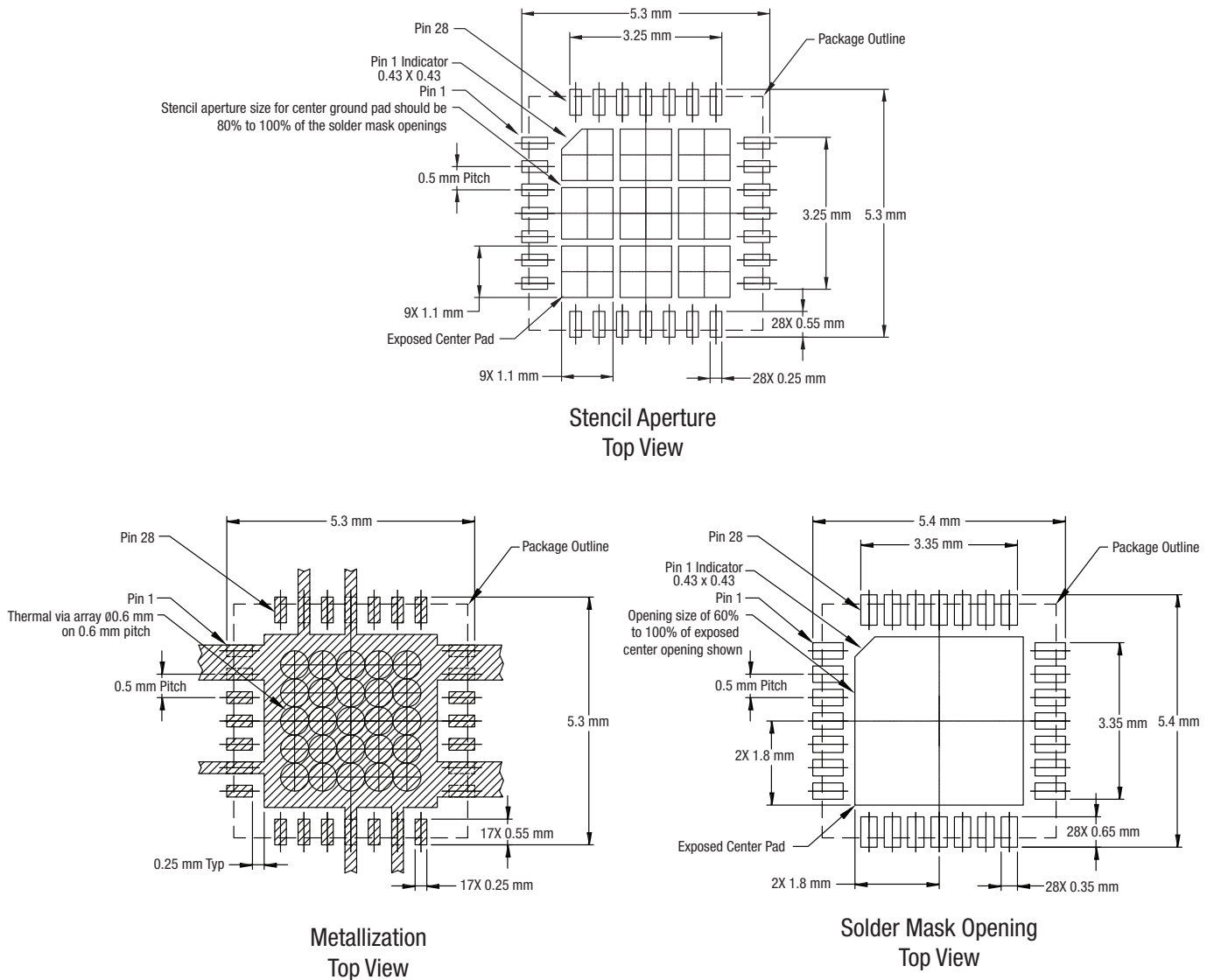

Figure 19. Typical Part Marking

DATA SHEET • SKY66189-11: 1930 to 1995 MHz Linear Power Amplifier



Notes:

1. Thermal vias should be resin filled and capped in accordance with IPC-4761 type VII vias.
2. Recommended Cu thickness is 30 to 35 μ m.

203312-015

Figure 20. SKY66189-11 PCB Layout Footprint

DATA SHEET • SKY66189-11: 1930 to 1995 MHz Linear Power Amplifier

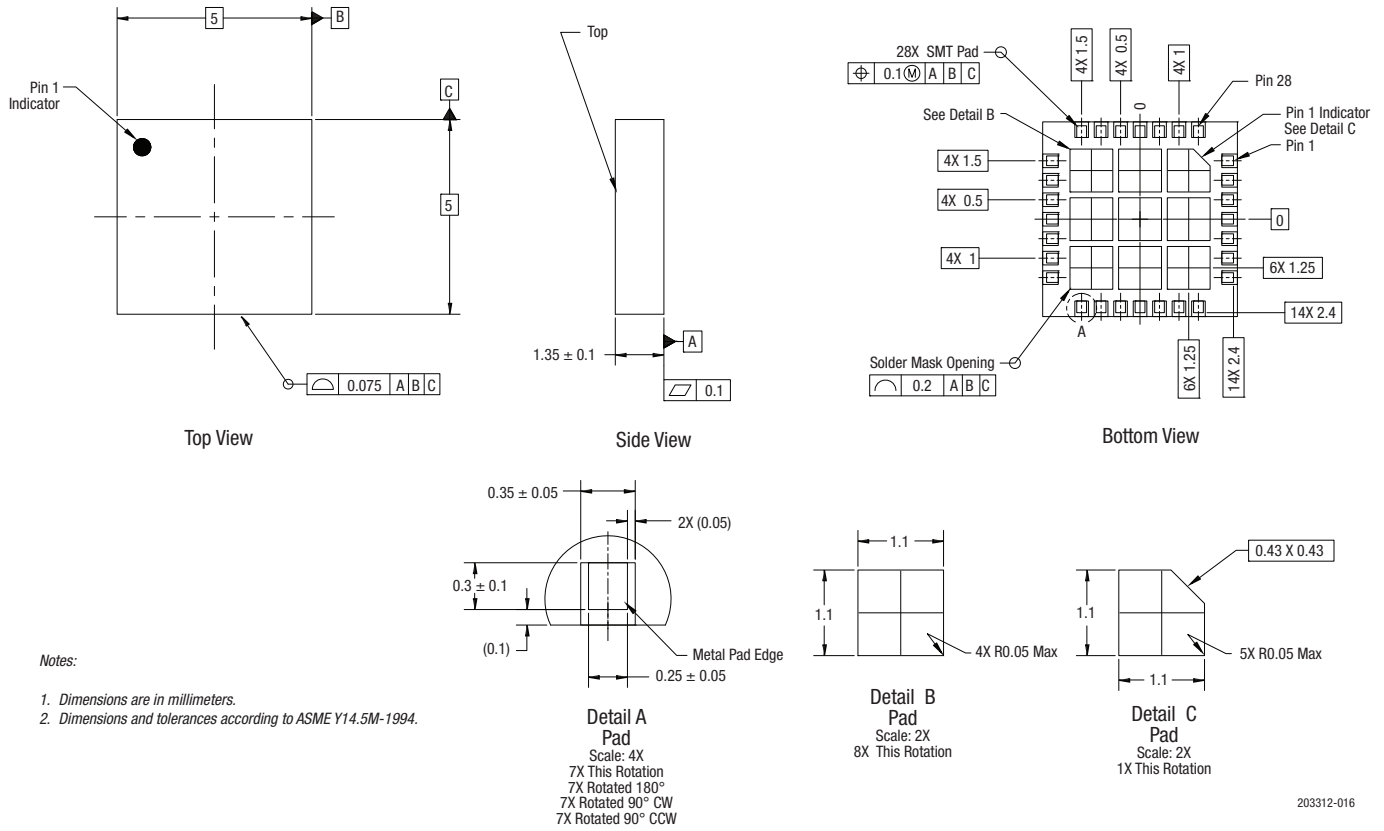
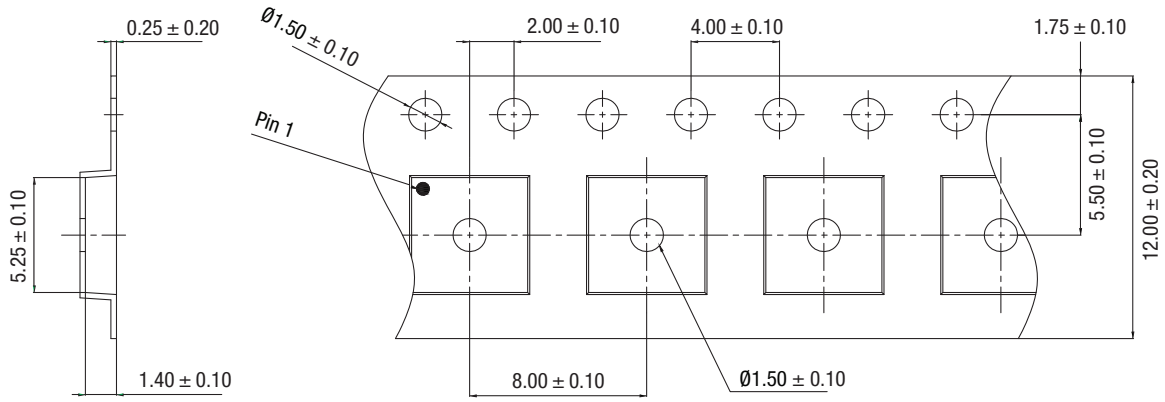
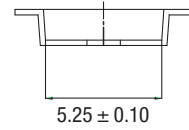

Figure 21. SKY66189-11 Package Dimensions



Notes:

1. Carrier tapes must meet all requirements of Skyworks GP01-D232 procurement spec for tape and reel shipping.
2. Carrier tape shall be black conductive polycarbonate.
3. Cover tape shall be transparent conductive material.
4. ESD-surface resistivity shall be $\leq 1 \times 10^{10} \Omega/\text{square}$ per EJA, JEDEC TNR specification.
5. All measurements are in millimeters.



203312-017

Figure 22. SKY66189-11 Tape and Reel Dimensions

Ordering Information

Part Number	Product Description	Evaluation Board Part Number
SKY66189-11	1930 to 1995 MHz Linear Power Amplifier	SKY66189-11-EK1

Copyright © 2015-2017, 2020 Skyworks Solutions, Inc. All Rights Reserved.

Information in this document is provided in connection with Skyworks Solutions, Inc. (“Skyworks”) products or services. These materials, including the information contained herein, are provided by Skyworks as a service to its customers and may be used for informational purposes only by the customer. Skyworks assumes no responsibility for errors or omissions in these materials or the information contained herein. Skyworks may change its documentation, products, services, specifications or product descriptions at any time, without notice. Skyworks makes no commitment to update the materials or information and shall have no responsibility whatsoever for conflicts, incompatibilities, or other difficulties arising from any future changes.

No license, whether express, implied, by estoppel or otherwise, is granted to any intellectual property rights by this document. Skyworks assumes no liability for any materials, products or information provided hereunder, including the sale, distribution, reproduction or use of Skyworks products, information or materials, except as may be provided in Skyworks Terms and Conditions of Sale.

THE MATERIALS, PRODUCTS AND INFORMATION ARE PROVIDED “AS IS” WITHOUT WARRANTY OF ANY KIND, WHETHER EXPRESS, IMPLIED, STATUTORY, OR OTHERWISE, INCLUDING FITNESS FOR A PARTICULAR PURPOSE OR USE, MERCHANTABILITY, PERFORMANCE, QUALITY OR NON-INFRINGEMENT OF ANY INTELLECTUAL PROPERTY RIGHT; ALL SUCH WARRANTIES ARE HEREBY EXPRESSLY DISCLAIMED. SKYWORKS DOES NOT WARRANT THE ACCURACY OR COMPLETENESS OF THE INFORMATION, TEXT, GRAPHICS OR OTHER ITEMS CONTAINED WITHIN THESE MATERIALS. SKYWORKS SHALL NOT BE LIABLE FOR ANY DAMAGES, INCLUDING BUT NOT LIMITED TO ANY SPECIAL, INDIRECT, INCIDENTAL, STATUTORY, OR CONSEQUENTIAL DAMAGES, INCLUDING WITHOUT LIMITATION, LOST REVENUES OR LOST PROFITS THAT MAY RESULT FROM THE USE OF THE MATERIALS OR INFORMATION, WHETHER OR NOT THE RECIPIENT OF MATERIALS HAS BEEN ADVISED OF THE POSSIBILITY OF SUCH DAMAGE.

Skyworks products are not intended for use in medical, lifesaving or life-sustaining applications, or other equipment in which the failure of the Skyworks products could lead to personal injury, death, physical or environmental damage. Skyworks customers using or selling Skyworks products for use in such applications do so at their own risk and agree to fully indemnify Skyworks for any damages resulting from such improper use or sale.

Customers are responsible for their products and applications using Skyworks products, which may deviate from published specifications as a result of design defects, errors, or operation of products outside of published parameters or design specifications. Customers should include design and operating safeguards to minimize these and other risks. Skyworks assumes no liability for applications assistance, customer product design, or damage to any equipment resulting from the use of Skyworks products outside of stated published specifications or parameters.

Skyworks, the Skyworks symbol, and Skyworks Green™ are trademarks or registered trademarks of Skyworks Solutions, Inc., in the United States and other countries. Third-party brands and names are for identification purposes only and are the property of their respective owners. Additional information, including relevant terms and conditions, posted at www.skyworksinc.com, are incorporated by reference.